

Technical Data

Q6 Series

Gas engine – Generating set specification

Q6.72TASI – NG- E

135 kW(m) @1500 RPM

For any further information, please contact the Quantum Team by visiting our website at <https://www.quantumes.com/contact-us/>

Basic technical data

Number of cylinders.....	6
Cylinder arrangement.....	Vertical in-line
Cycle.....	Four stroke
Induction system.....	Turbocharged and air charge cooled
Compression ratio.....	13:1
Bore.....	105mm
Stroke.....	135mm
Cubic capacity.....	7.01 litres
Direction of rotation.....	Clockwise view from front
Firing order.....	1-5-3-6-2-4

Overall dimensions of EpaK

Height.....	1095mm
Length.....	1711mm
Width (including mounting brackets).....	760mm

Moments of inertia

Engine Rotational components.....	0.27kgm ²
Flywheel.....	1.20kgm ²

Centre of gravity

Forward from rear of block.....	476mm
Above centre line of block.....	176mm
Offset of RHS of centre line.....	16mm

Test conditions

Air temperature.....	25°C
Barometric pressure.....	100kPa
Relative humidity.....	31.5%

If the engine is to operate in ambient conditions other than those of the test conditions, suitable adjustments must be made for these changes. For full details, contact Quantum Technical Service Department

Estimated total weight

(incl. radiator and mounting brackets)

Total weight (engine only)	
Dry.....	740kg
Wet.....	784kg

Designation	50Hz Operation		
	Units	Prime	Stand-by
Engine speed	RPM	1500	1500
Gross engine power	kWm	135	149
Brake mean effective pressure (calc.)	kPa	1522	1677
Engine coolant flow 35 kPa restriction	L/min	142	142
Combustion air flow	m ³ /min	10.9	11.7
Exhaust gas flow (max – calc.)	m ³ /min	22.2	28.9
Exhaust gas outlet temperature (avg.)	°C	520	TBC
Cooling fan air flow (200kPa external restriction)	m ³ /min	220	220
Overall thermal efficiency (net – calc.)	%	36.1	37.0
Typical genset electrical output	kW(e)	120	133
	kVA	150	166
Power factor		0.8	0.8
Actual alternator efficiency	%	93.4	93.4

Sound

Sound pressure level* (cooling pack and air cleaner fitted)	
@1500RPM.....	109.82dB(A)
@1800RPM.....	TBC

*Sound level values correspond to a diesel configuration. Equivalent gas models are currently unavailable but typically operate at lower noise levels.

Rating Definitions

Prime Power – Unlimited hours usage with an average load factor of 80% of the published Prime power over each 24 hours period. A 10% overload is available for 1 hour in every 12 hours of operation.

Standby power – Limited to 500 hours annual usage with an average load factor of 80% of the published Standby power rating over each 24 hours period. Up to 300 hours of annual usage may be run continuously. No overload is permitted on Standby power

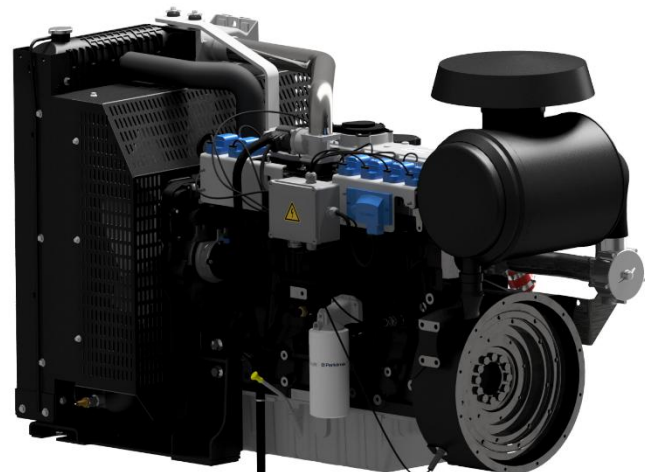

Caution: The airflows shown in this table will provide acceptable cooling for an open power unit operating in ambient temperatures of up to 53 °C (127 °F) or 46 °C (114.8 °F) if a canopy is fitted. If the power unit is to be enclosed totally, a cooling test should be done to check that the engine cooling is acceptable. If there is insufficient cooling, contact Quantum Technical Service Department.

Cooling System (Inc intercooler)

Face area.....	0.494m ²
Rows and materials.....	4 row aluminium
Matrix density and material.....	11.3 aluminium fins/inch
Width of matrix.....	716mm
Height of matrix.....	690mm

Fan

Diameter.....	635mm
Drive ratio.....	1.25 :1
Number of blades.....	7
Material.....	Nylon
Type.....	Pusher

Coolant**

Capacity (incl. radiator).....	20.5 litres
Capacity (not incl. radiator).....	9.5 litres
Maximum top tank temperature.....	110°C
Thermostat operating range.....	82-93°C

**Recommended coolant: BS6580 – 1992, ASTM D3306 and ELC coolants to 1E1966

Electrical System

Type.....	Negative ground
Alternator voltage.....	12V
Starter motor voltage.....	12V
Starter motor power.....	4.2kW
Number of teeth on flywheel.....	126
Pull in current of starter motor solenoid.....	68 amps
Hold in current of starter motor solenoid.....	20 amps

Battery requirement

Min. 2x 12V battery CCA. 1200

Cold start recommendations

Minimum cranking speed.....	60RPM
-----------------------------	-------

Exhaust System

Maximum back pressure (@1500RPM).....	6kPa
Exhaust outlet size.....	72mm

Fuel System

Type or carburetor.....	Mixer / EFR
Throttle Actuator.....	Electronically controlled butterfly
Gas supply pressure.....	Min 17mbar*

*For supply pressure below this value, please contact Quantum Technical Dept. for advice.
Installation of gas supply and shut-off valves to be in accordance with local regulations.

Ignition system

Primary system type.....	Electronic inductive system
Ignition coils.....	1 per cylinder

Low Load Limits

@60-100% of prime rated power.....	No restriction
@30-60% of prime rated power.....	Max. 500h/yr (5hr continuous)
@0-30% of prime rated power.....	10 minutes

*If engine is run at less than 60% of prime rate power, it should be run at full power for at least 1 hour. (Start up and commissioning not included)

Fuel Specification

Recommended fuel – Natural gas with LHV at 35.66 MJ/m³ (fuel consumption basis).

Gas supplies must be filtered to the same standard as the engine intake air i.e. maximum particle size to not exceed 5 microns.

Fuel Consumption

Speed (RPM)	% of Prime power (Nm ³ /h)				
	110%	100%	75%	50%	25%
1500	38.7	36.0	29.9	23.0	16.5
1800	TBC	TBC	TBC	TBC	TBC

Induction System (maximum air intake restriction)

Clean filter.....	3kPA
Dirty filter.....	5kPA
Air filter type.....	Dry

Lubrication System (lubricating oil capacity)

Total system.....	18.0 litres
Sump only.....	12.5/16.1 litres (min/max)

Maximum Engine Operating Angles

Front up, front down, right side or left side.....	25°
--	-----

Lubricating Oil Pressure

Relief valve opens.....	460kPa
At maximum no-load speed.....	520kPa
Maximum oil temp.....	125°C
Sump drain plug tapping size.....	¼ - 16 UNF

Recommended Lubricating Oils

A single or multigrade oil must be used of low ash type (<0.6 %wt), formulated for natural gas engines. See chart below for temperature range.

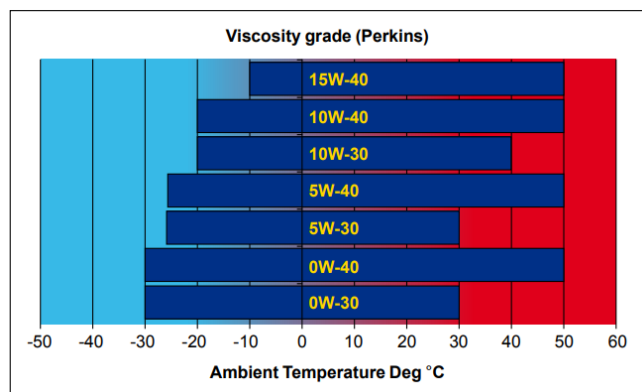

Mountings

Maximum static bending moment at rear face of block.....	1130Nm
--	--------

Flywheel and housing

Flywheel housing.....	SAE 3
Flywheel.....	10/11.5

The information given in this document is for guidance only. All tests were conducted using engine installed and services to Quantum ES Ltd recommendations.

All information in this datasheet is correct at time of print but is subject to change without prior notice

REAR SIDE VIEW

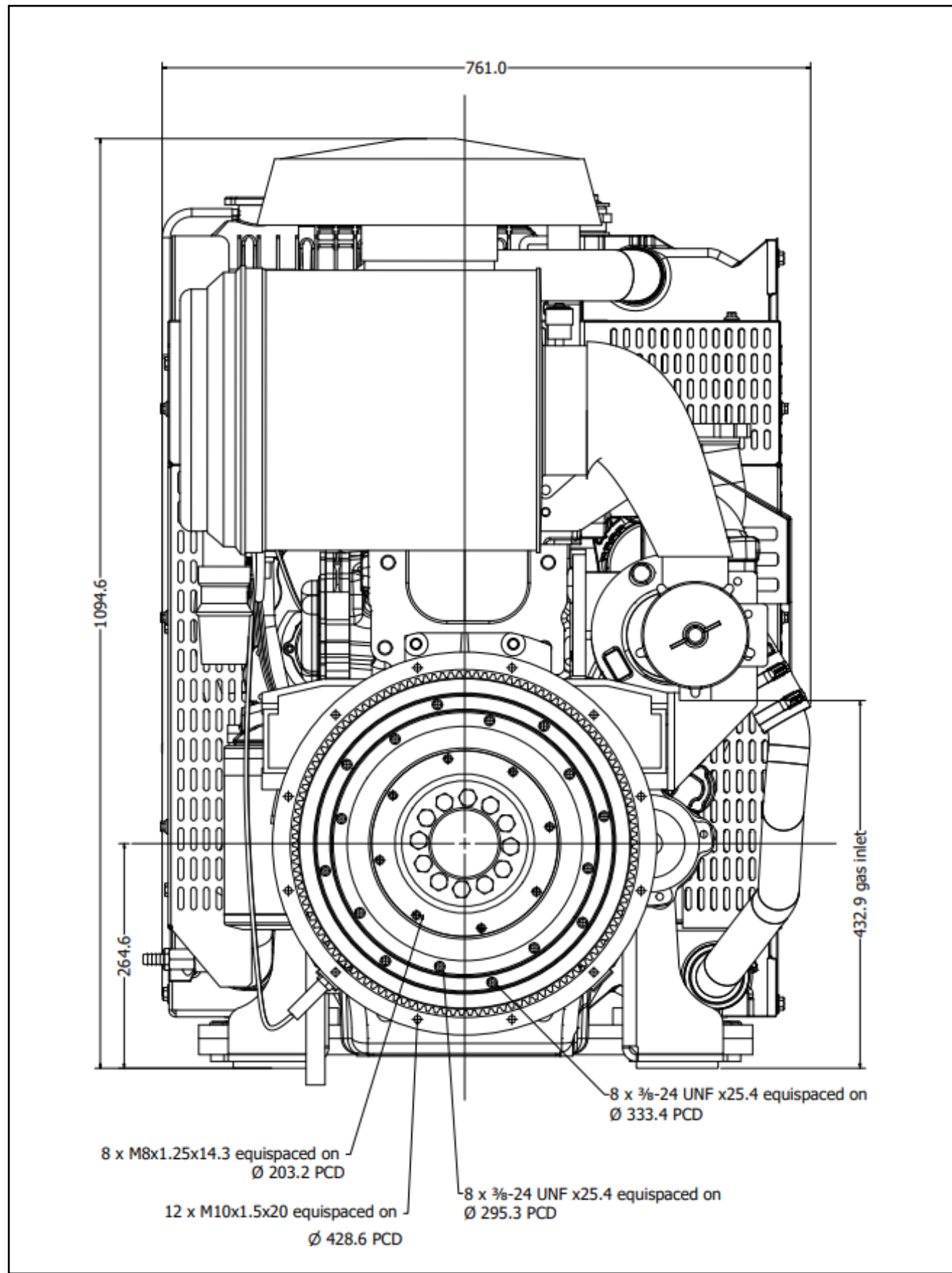

RIGHT SIDE VIEW

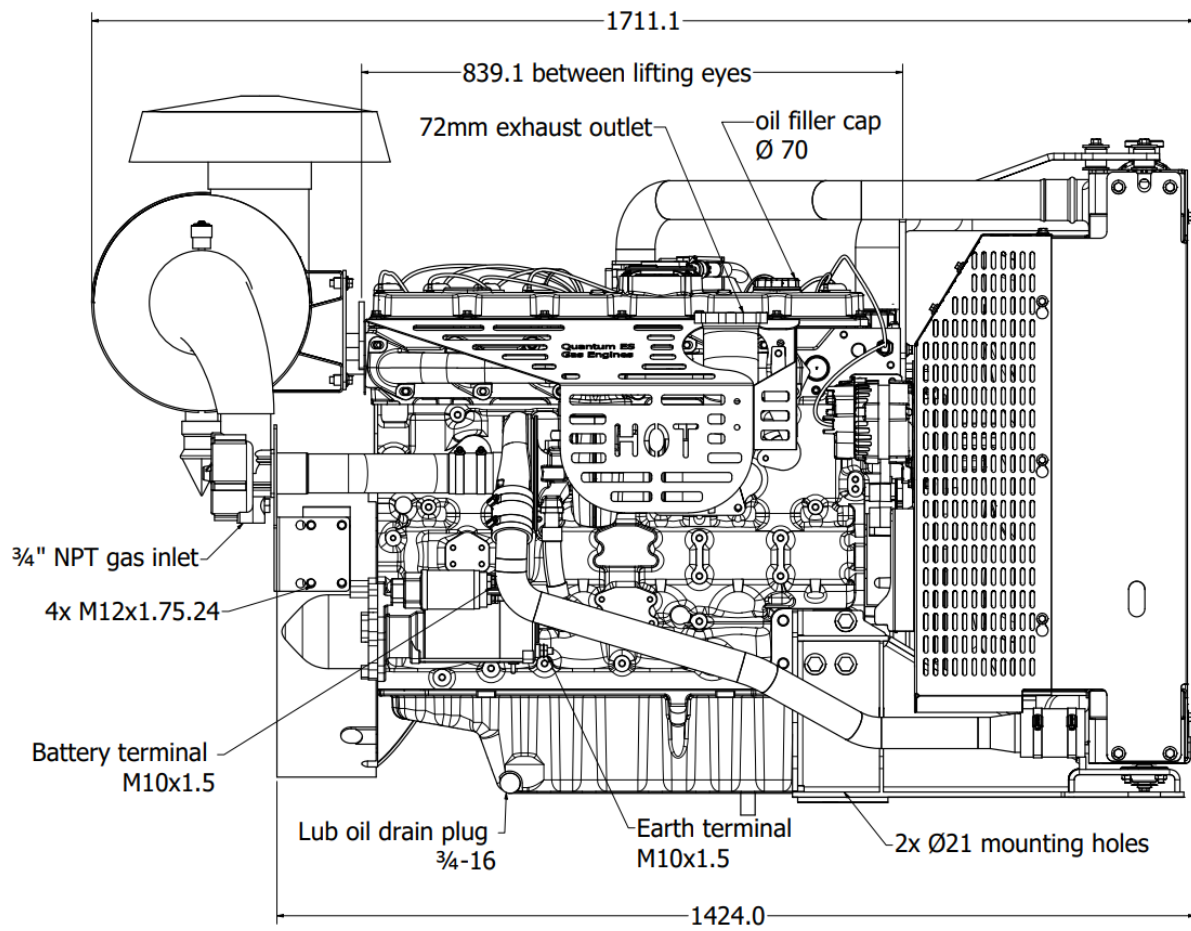

FRONT SIDE VIEW

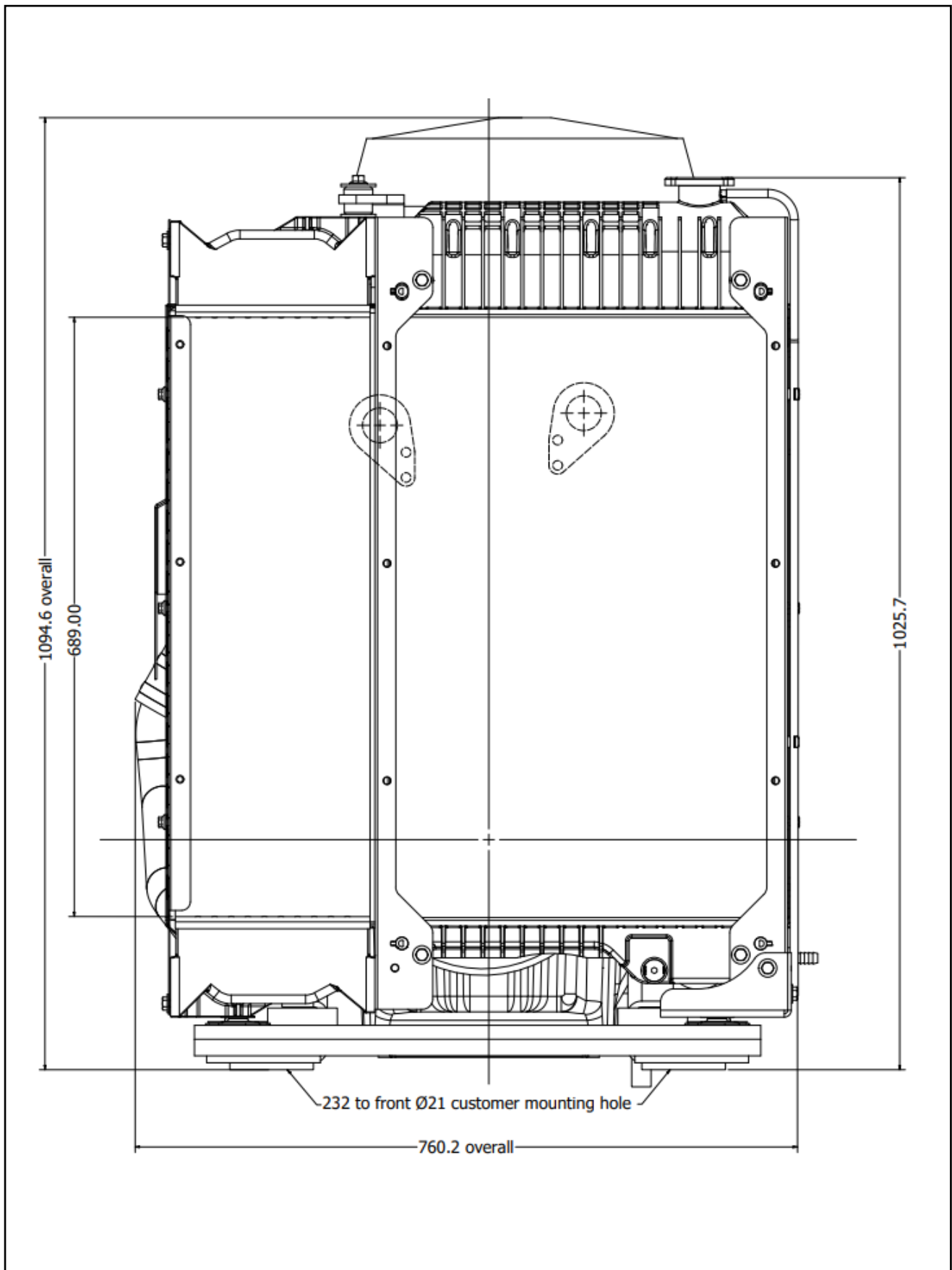

LEFT SIDE VIEW

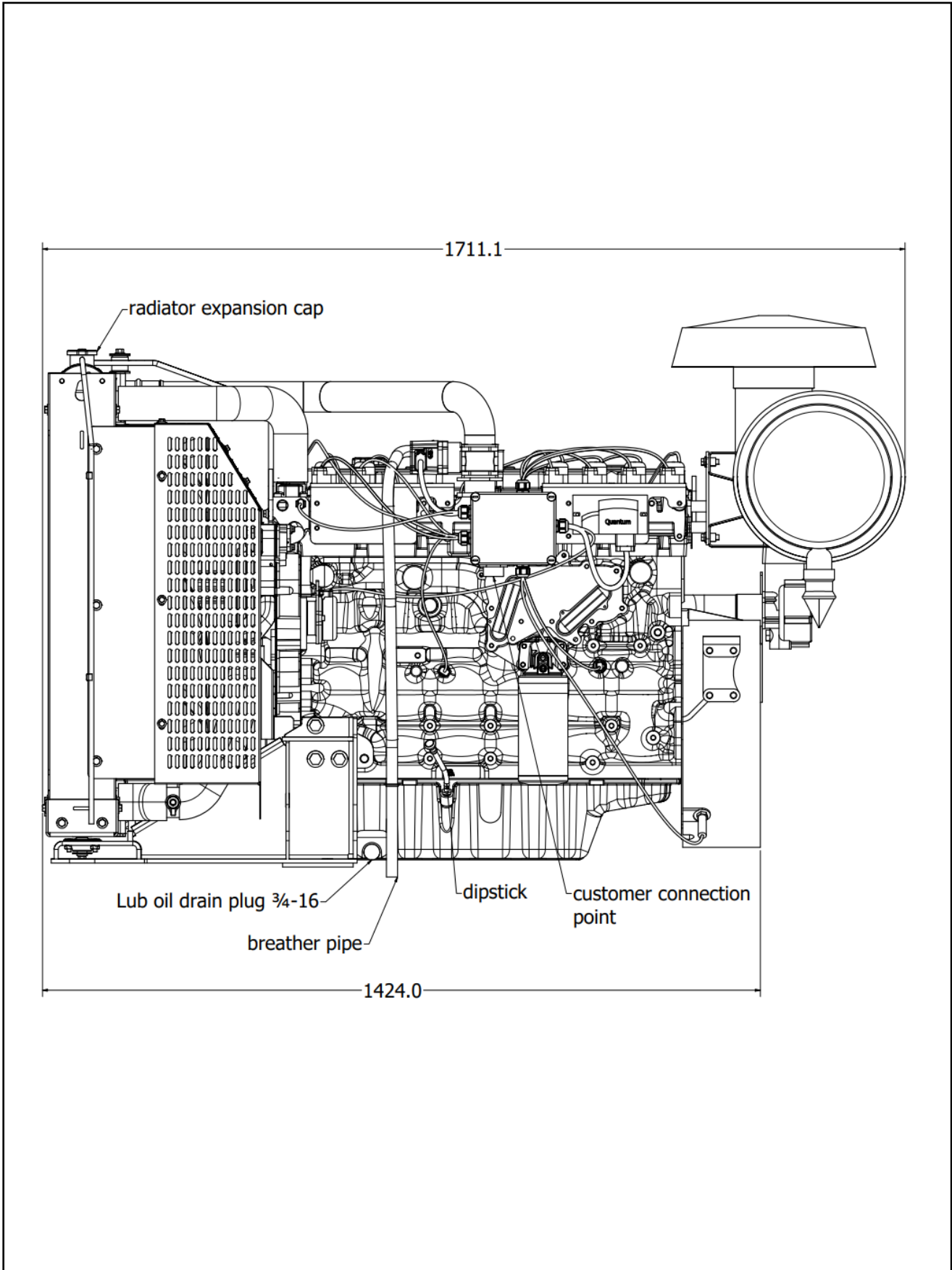

TOP DOWN VIEW

